

Placement of Safety Decals on Sweepway

Safety decals #1 - #5 should be mounted on your equipment as shown on this page. Safety decals #1 and #4 must be mounted during installation. Make sure location area for decal is free from grease, oil and dirt. Remove backing from decal and place in proper position.

Important: If suggested locations are not clearly visible, place safety decals in a more suitable area. Never cover up any existing safety decals.

! Yearly and prior to equipment use, please check that all decals and shields are in place according to these drawings and in good legible condition. To order a replacement decal or shield (NO CHARGE) contact your dealer or **Sukup Manufacturing Co., Box 677, Sheffield, IA 50475.**

1. WARNING - L0281 - Safe operation.

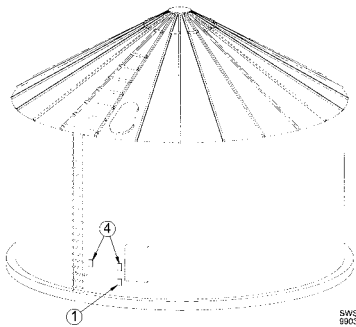

2. DANGER - L0271- Replace missing shield.



3. WARNING - L0284 - Keep away from moving parts.



4. DANGER - L0301 - Mount this decal on bin sheet near door handle and all other entry points or by ladder going to roof.



5. DANGER - L0250 - Keep away! Rotating drive line.



HORIZONTAL

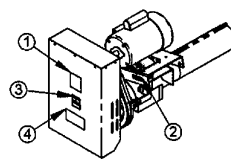

VERTICAL BOOT

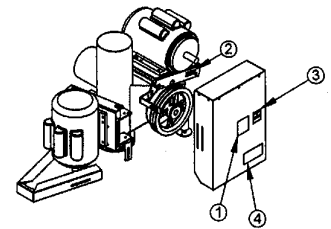

STANDARD ONE MOTOR DRIVE

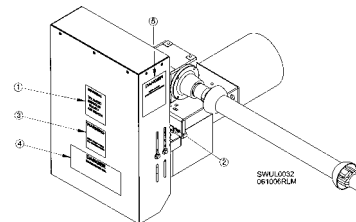

TWO MOTOR DRIVE (STANDARD)

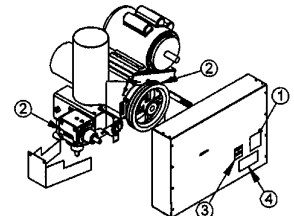

POWER-TAKE-OFF DRIVE

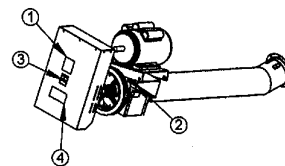

INCLINE HORIZONTAL DRIVE

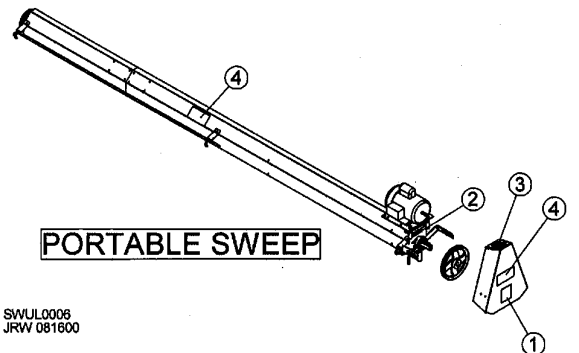

SWUL0006
JRW 081600

SWUL0007
JRW 081600

PORTABLE SWEEP